

# Aluminium extension arm WT-14/2

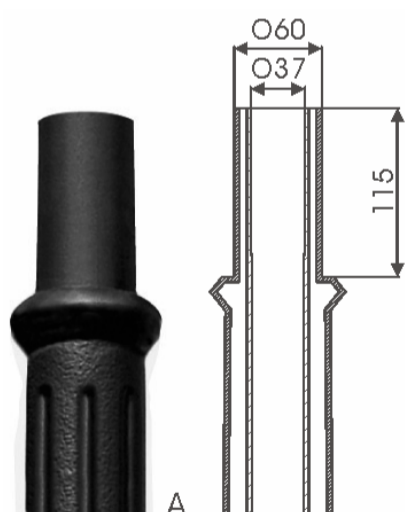
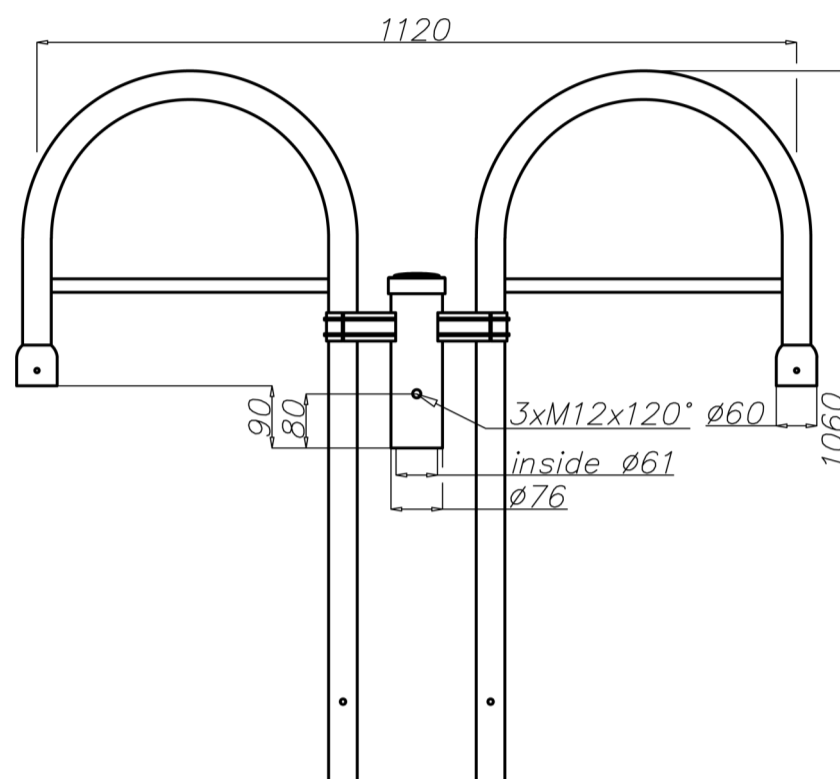

## Technical data

Extension arm	WT-14/2
Product code	477142/C35
Application	poles type SP with spigot ending "A"
Arm quantity	2
Net weight [kg]	5,2
Volume [m <sup>3</sup> ]	0,024
Assembling diameter of luminaire [mm]	Ø 60
Compatible luminaires	OP 400, OP 450

- standard anodized in black
- possibility of anodizing in other colours
- option of powder painting in RAL colours (other colours available on request)
- possibility of making assembling diameter of luminaire Ø 42 mm for OPA
- packing: stretch foil