

Aluminium extension arm WT-8/3

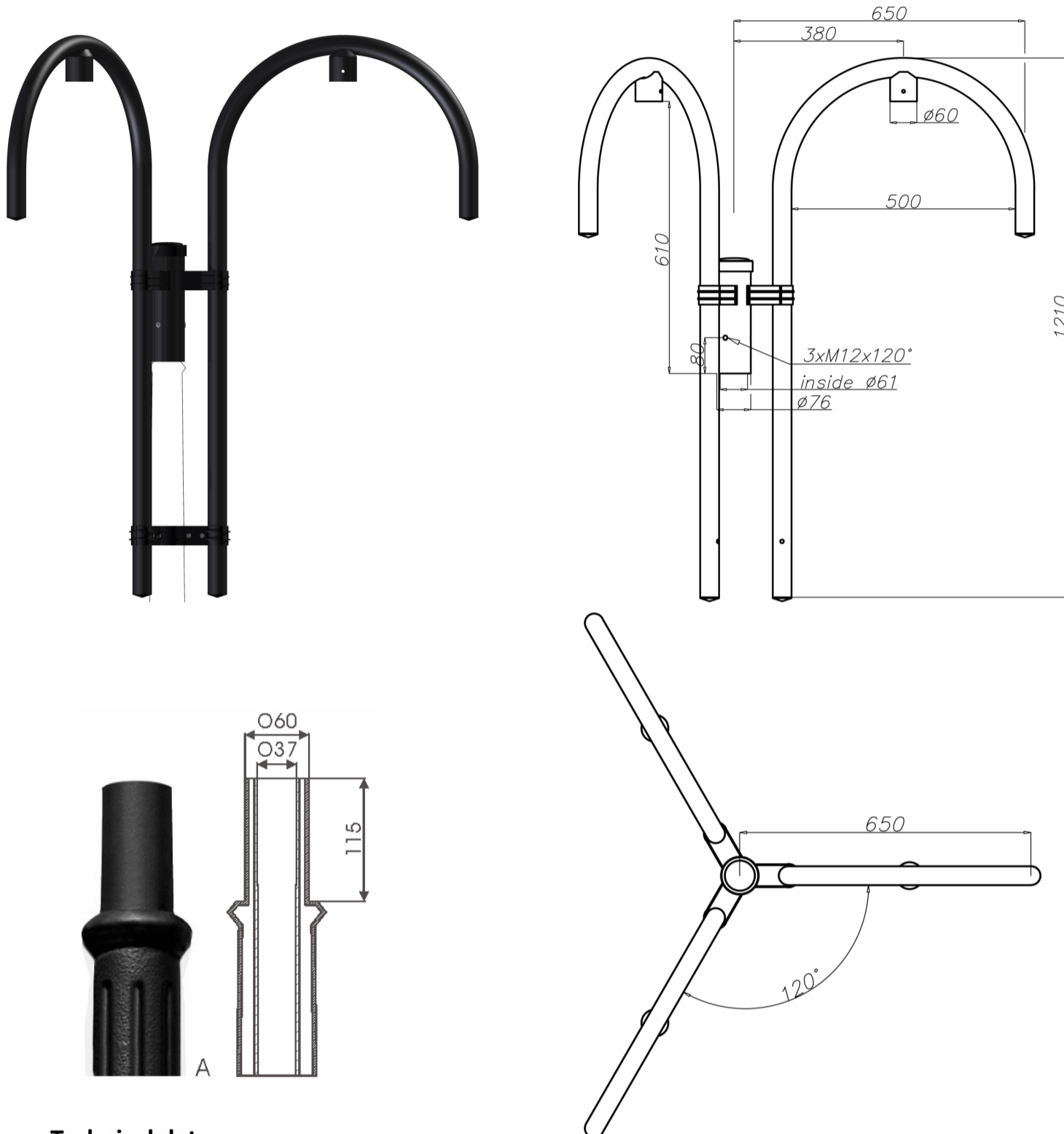

Technical data

Extension arm	WT-8/3
Product code	477083/C35
Application	poles type SP with spigot ending "A"
Arm quantity	3
Net weight [kg]	7,5
Volume [m ³]	0,13
Assembling diameter of luminaire [mm]	Ø 60
Compatible luminaires	OP 400

- standard anodized in black
- possibility of anodizing in other colours
- option of powder painting in RAL colours (other colours available on request)
- possibility of making assembling diameter of luminaire Ø 42 mm for OPA
- packing: stretch foil