

Aluminium extension arm WRK-4

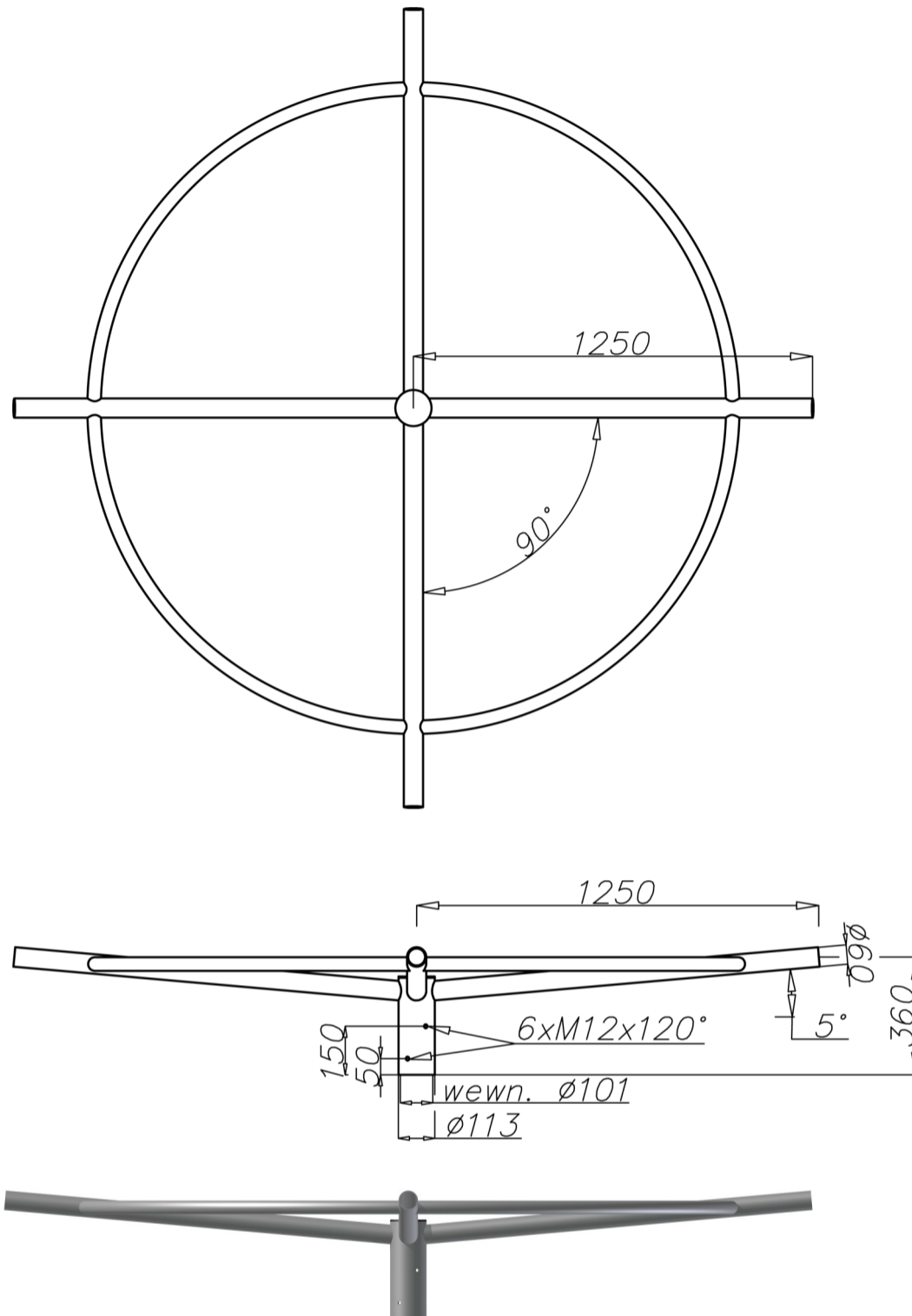

Technical data

Extension arm	WRK-4
Product code	475040
Application	aluminium light masts with ending $\varnothing 100 \times 180$
Arm quantity	4
Net weight [kg]	18
Windage [m ²]	0,26
Volume [m ³]	0,81
Assembling diameter of luminaire \varnothing [mm]	$\varnothing 60$
Compatible luminaires	street luminaires

- anodising in 10 colours, each with possibility of brightening
- option of powder painting in RAL colours (other colours available on request)
- packing: sleeve material
- CE certificate valid for use on poles manufactured by ROSA company