

Aluminium extension arm WR-1/1

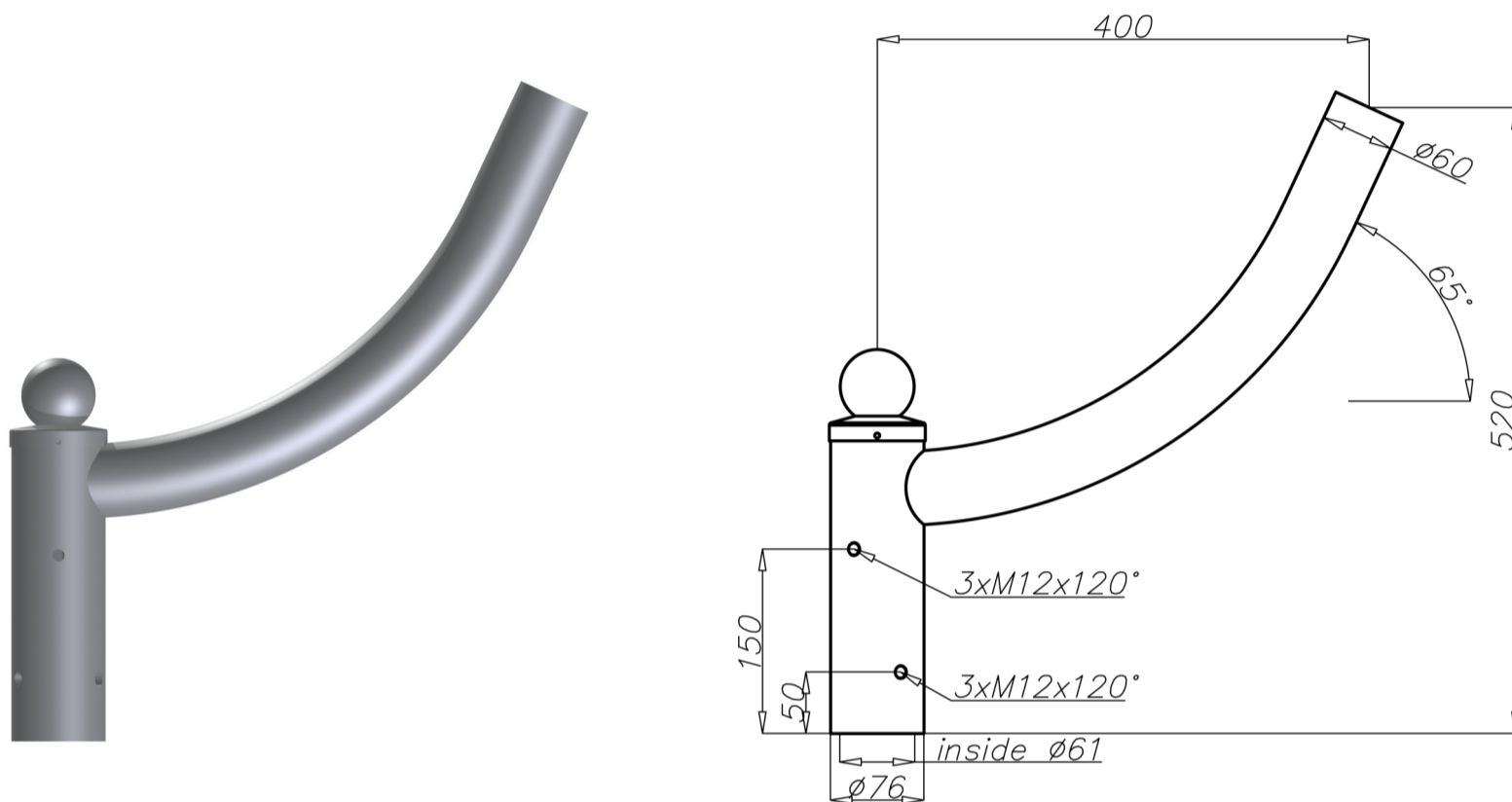

Technical data

Extension arm	WR-1/1
Product code	472011
Application	aluminium columns with ending ø60x180
Arm quantity	1
Net weight [kg]	1,8
Windage [m ²]	0,053
Volume [m ³]	0,01
Assembling diameter of luminaire [mm]	ø 60x100
Compatible luminaires	street luminaires

- anodising in 10 colours, each with possibility of brightening
- option of powder painting in RAL colours (other colours available on request)
- packing: sleeve material
- CE certificate valid for use on poles manufactured by ROSA company