

Technical data

Pole			S-31W**
Height H [m]			3,32
Colour			black
Standard pole (code)	Spigot ending	A	13111
		B	13121
High thermal resistance pole (code)		A	13111F
		B	13121F
Net weight [kg]	A	30,0	
Volume [m ³]*	B	27,0	
	A, B	0,12	
Pole top mounted			pole spigot „B” – Ø60 – OS-1, OP, OPA-1
Compatible extension arms			pole spigot „A” – Ø60 – arm systems: 1, 2, 2+1, 3, 3+1
Concrete footing / reinforcement basket			B-30 / Z-30
Concrete footing code/reinforcement basket			311130 / 311203
Nut set code			311003

* For order of more than 10 pcs stated volume may change according to packing

** pole with chamber



Spigot ending types

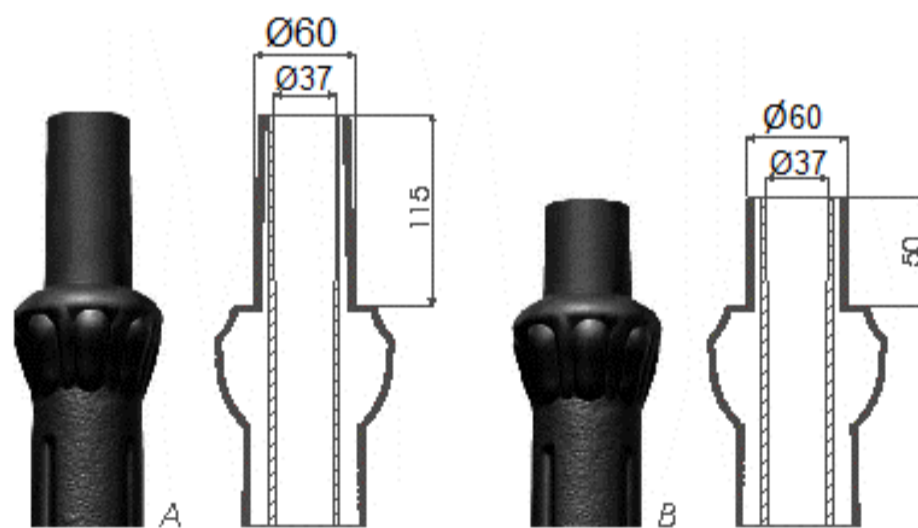

Pole base scheme

